

2.6

10 mm Solenoid Valves

MMD 510 301 24DC/MMD 510 341 24DC

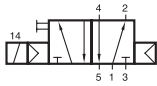

MMD 510 301 24DC
MMD 510 341 24DC



5/2-way solenoid valve actuated by permanent signal and equipped with air spring return.

Available with 24V= solenoid system for connector according to JPC standard.
12V= available on request.

Solenoid with integrated LED and varistor.
Protection class IP 40.

Valves are generally equipped with manual override to push.

Connector according to JPC standard with a cable length of 300 mm is included.

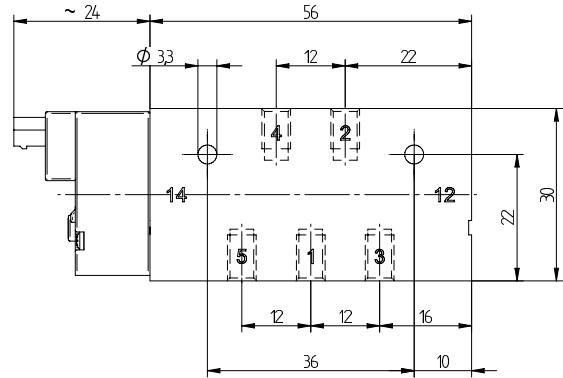

MMD 510 301 24DC

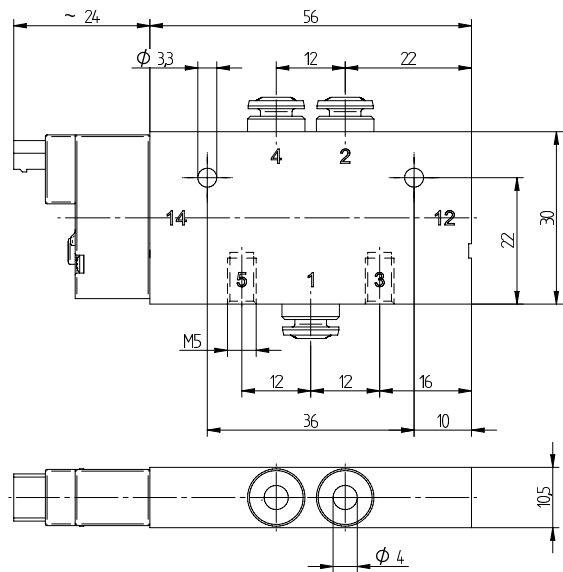

MMD 510 341 24DC

Type	Ports 1,2,3	Air flow	Operating press.	Power cons.	Weight
MMD 510 301 24DC	M5	230 l/min	3 - 8 bar	0,6 W	0,058 kg
MMD 510 341 24DC	pif 4 mm	230 l/min	3 - 8 bar	0,6 W	0,064 kg

MMD 520 301 24DC/MMD 520 341 24DC

MMD 520 301 24DC
MMD 520 341 24DC

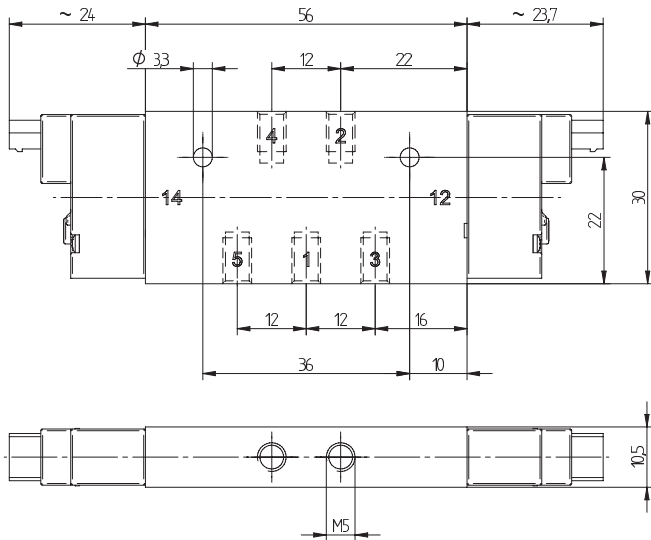
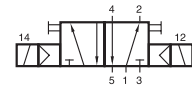

MMD 520 301 24DC

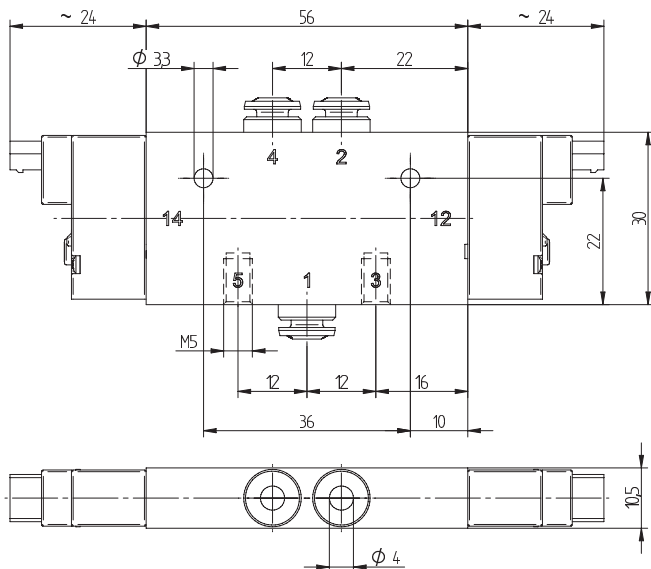

MMD 520 341 24DC



5/2-way double solenoid valve actuated by impulse. Position is kept until an electrical signal is applied to the opposite side even when not attached to electrical signal.

Available with 24V= solenoid system for connector according to JPC standard.
12V= available on request.

Solenoid with integrated LED and varistor.
Protection class IP 40.

Valves are generally equipped with manual override to push.

Connectors according to JPC standard with a cable length of 300 mm are included.

Type	Ports 1,2,3	Air flow	Operating press.	Power cons.	Weight
MMD 520 301 24DC	M5	230 l/min	3 - 8 bar	0,6 W	0,058 kg
MMD 520 341 24DC	pif 4 mm	230 l/min	3 - 8 bar	0,6 W	0,064 kg

MMD 53_ 301 24DC/MMD 53_ 341 24DC

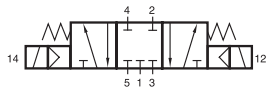

MMD 531 301 24DC
MMD 531 341 24DC

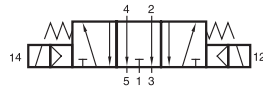

MMD 532 301 24DC
MMD 532 341 24DC

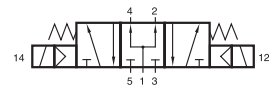

MMD 533 301 24DC
MMD 533 341 24DC



5/3-way solenoid valve with spring return to middle position, actuated by permanent signal.

Type 531 centre closed
Type 532 centre exhausted
Type 533 centre pressurized

When ordering please complete the type number by 1, 2 or 3 according to the type required.

Available with 24V= solenoid system for connector according to JPC standard.
12V= available on request.

Solenoid with integrated LED and varistor.
Protection class IP 40.

Valves are generally equipped with manual override to push.

Connectors according to JPC standard with a cable length of 300 mm are included.

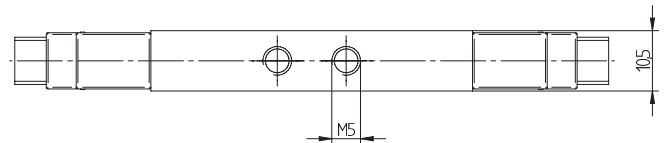
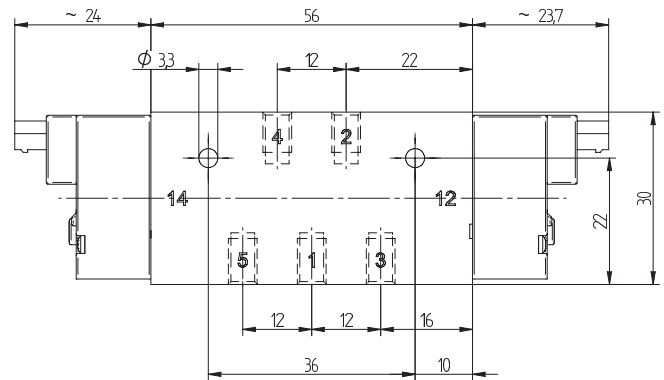

MMD 510 301 24DC

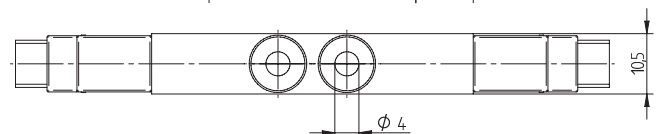
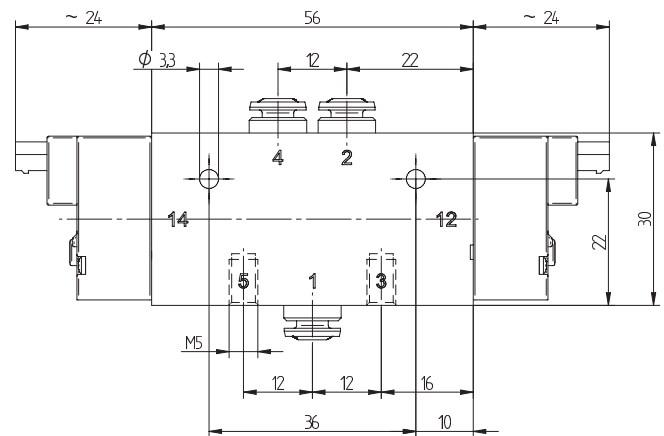

MMD 510 341 24DC

Type	Ports 1,2,3	Air flow	Operating press.	Power cons.	Weight
MMD 53_ 301 24DC	M5	230 l/min	3 - 8 bar	0,6 W	0,068 kg
MMD 53_ 341 24DC	pif 4 mm	230 l/min	3 - 8 bar	0,6 W	0,074 kg

MMD 231 304 24DC / MMD 232 304 24DC MMD 233 304 24DC

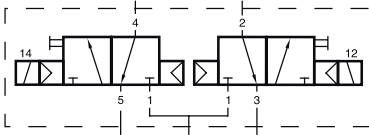

MMD 231 304 24DC

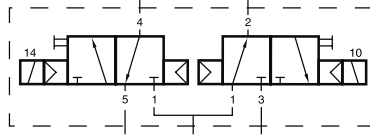

MMD 232 304 24DC

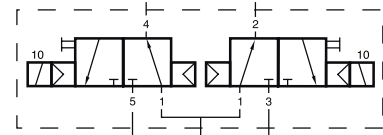

MMD 233 304 24DC

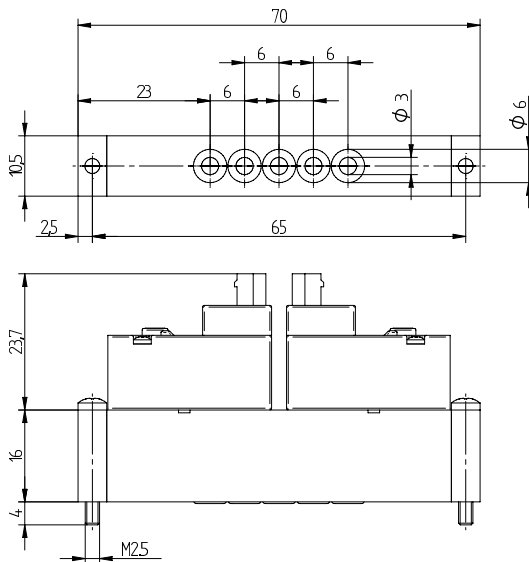
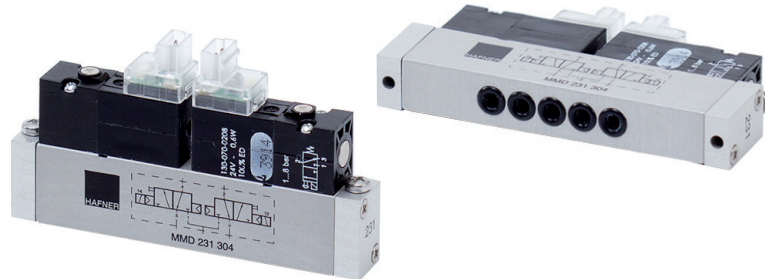

MMD 23_304 24DC

Double 3/2-way solenoid valve actuated by permanent signal and equipped with air spring return.

Type 231	NC & NC
Type 232	NC & NO
Type 233	NO & NO

When ordering please complete the type number by 1, 2 or 3 according to the type required.

Available with 24V= solenoid system for connector according to JPC standard.
12V= available on request.

Solenoid with integrated LED and varistor.
Protection class IP 40.

Valves are generally equipped with manual override to push.

Connectors according to JPC standard with a cable length of 300 mm are included.

Modular manifold system type RM 5 304 on page 2.6.2.4, valve terminals on page 2.6.2.5.

Type	Ports 1,2,3	Air flow	Operating press.	Power cons.	Weight
MMD 23_304 24DC	Ø 3 mm	230 l/min	3 - 8 bar	0,6 W	0,054 kg

MMD 510 304 24DC/MMD 520 304 24DC

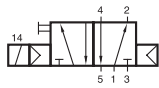

MMD 510 304 24DC

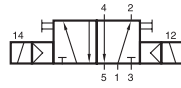

MMD 520 304 24DC

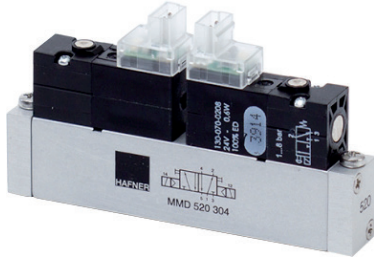

MMD 510 304

5/2-way solenoid valve actuated by permanent signal and equipped with air spring return. All the ports are in the plate.

MMD 520 304

5/2-way double solenoid valve actuated by impulse. Position is kept until an electrical signal is applied to the opposite side even when not attached to electrical signal. All the ports are in the plate.

Available with 24V= solenoid system for connector according to JPC standard.
12V= available on request.

Solenoid with integrated LED and varistor.
Protection class IP 40.

Valves are generally equipped with manual override to push.

Connector according to JPC standard with a cable length of 300 mm is included.
MMD 520 304 24DC equipped with two connectors.

Modular manifold system type RM 5 304 on page 2.6.2.4, valve terminals on page 2.6.2.5.

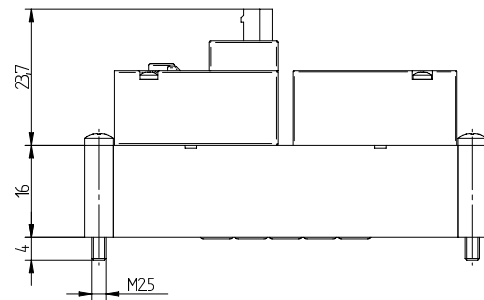
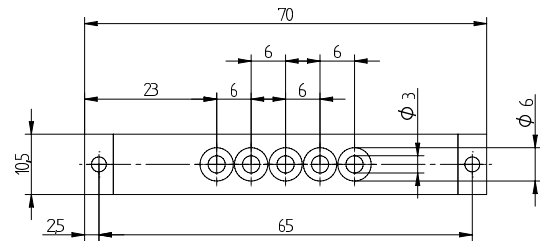

MMD 510 304 24DC

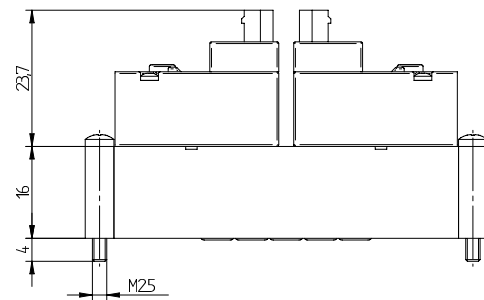
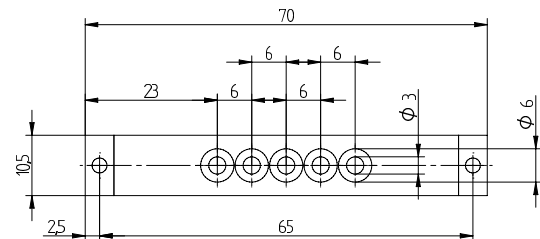

MMD 520 304 24DC

Type	Ports 1,2,3	Air flow	Operating press.	Power cons.	Weight
MMD 510 304 24DC	Ø 3 mm	230 l/min	3 - 8 bar	0,6 W	0,054 kg
MMD 520 304 24DC	Ø 3 mm	230 l/min	3 - 8 bar	0,6 W	0,054 kg

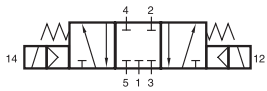

MMD 531 304 24DC

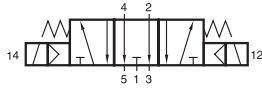

MMD 532 304 24DC

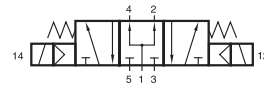

MMD 533 304 24DC

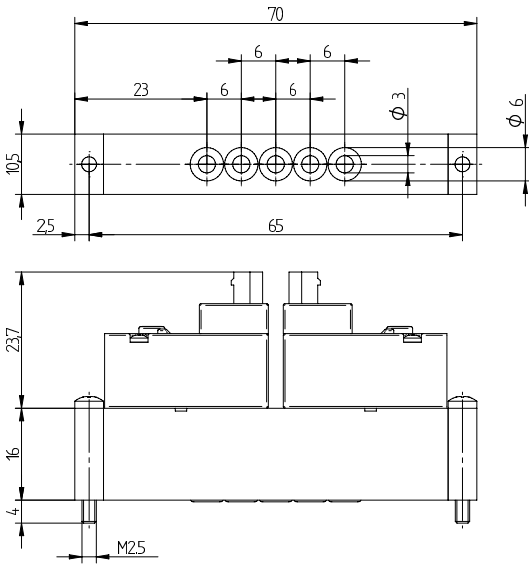
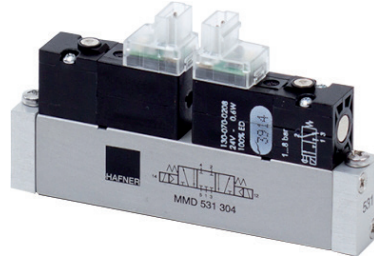

MMD 53_ 304 24DC

5/3-way solenoid valve with spring return to middle position, actuated by permanent signal. All the ports are in the plate.

- Type 531 centre closed
- Type 532 centre exhausted
- Type 533 centre pressurized

When ordering please complete the type number by 1, 2 or 3 according to the type required.

Available with 24V= solenoid system for connector according to JPC standard.
12V= available on request.

Solenoid with integrated LED and varistor.
Protection class IP 40.

Valves are generally equipped with manual override to push.

Connectors according to JPC standard with a cable length of 300 mm are included.

Modular manifold system type RM 5 304 on page 2.6.2.4, valve terminals on page 2.6.2.5.

Type	Ports 1,2,3	Air flow	Operating press.	Power cons.	Weight
MMD 53_ 304 24DC	Ø 3 mm	230 l/min	3 - 8 bar	0,6 W	0,054 kg

RM 5__ 344

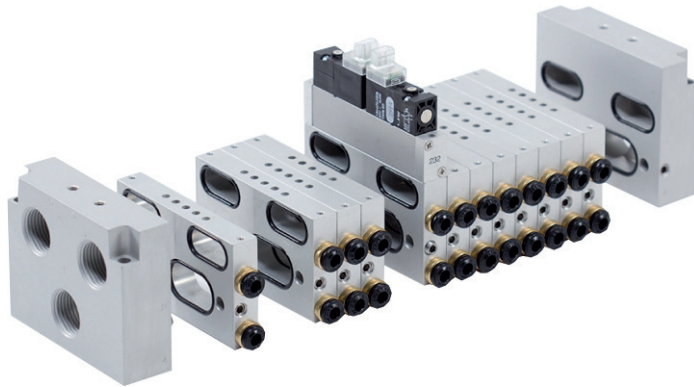

Modular manifold system for common connection to ports 1 (pressure), 3 and 5 (exhaust). Ports 2 and 4 of the individual valves are also located in the manifold plate and equipped with 4 mm push-in fittings.

The system can be build and taken apart just by operating two hexagon socket screws. Additional stations can be added at any position and any time.

Valves to be screwed from the top onto the modular manifold plate.

Blanking plates are also available type BPM 5 304. The plates can also be ordered assembled by the manufacturer. In this case order RM 5__ 344. Please add two digits for the number of positions required.

End-plates do not offer a valve-position.

The following valves can be assembled to the manifold plate RM 5__ 304:

Type	Function	Page
MMD 231 304 24DC	Double 3/2-way (NC&NC)	2.6.2.1
MMD 232 304 24DC	Double 3/2-way (NC&NO)	2.6.2.1
MMD 233 304 24DC	Double 3/2-way (NO&NO)	2.6.2.1
MMD 510 304 24DC	5/2 single sol.	2.6.2.2
MMD 520 304 24DC	5/2 double sol.	2.6.2.2
MMD 531 304 24DC	5/3 solenoid, closed	2.6.2.3
MMD 532 304 24DC	5/3 solenoid, exhausted	2.6.2.3
MMD 533 304 24DC	5/3 solenoid, pressurized	2.6.2.3

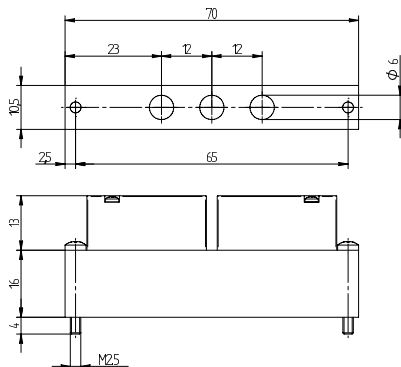

BPM 5 304

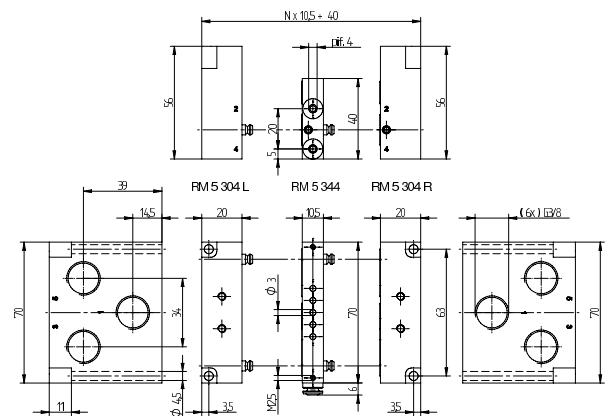

RM 5 304 L/RM 5 344/RM 5 304 R

Type	Function	Ports	Weight
RM 5 304 L	End-plate left	G 3/8"	0,176 kg
RM 5 304 R	End-plate right	G 3/8"	0,176 kg
RM 5 344	Individual position	pif 4 mm	0,064 kg
BPM 5 304	Blanking plate	-	0,054 kg

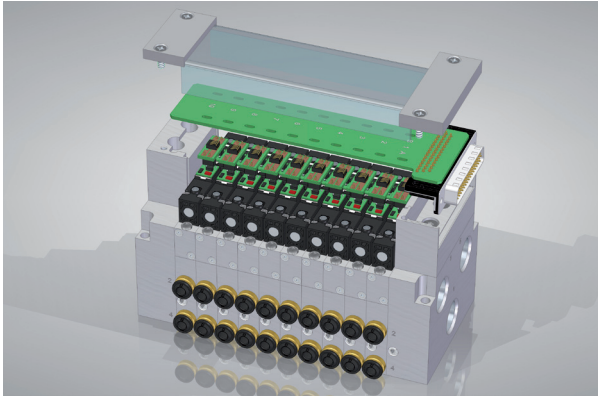

The following valves can be assembled to the valve terminal T_10 5__ 344:

Type	Function	Page
MMD 231 304 24DC	Double 3/2-way (NC&NC)	2.6.2.1
MMD 232 304 24DC	Double 3/2-way (NC&NO)	2.6.2.1
MMD 233 304 24DC	Double 3/2-way (NO&NO)	2.6.2.1
MMD 510 304 24DC	5/2 single sol.	2.6.2.2
MMD 520 304 24DC	5/2 double sol.	2.6.2.2
MMD 531 304 24DC	5/3 solenoid, closed	2.6.2.3
MMD 532 304 24DC	5/3 solenoid, exhausted	2.6.2.3
MMD 533 304 24DC	5/3 solenoid, pressurized	2.6.2.3



Valve terminal with 2 to 20 valve positions for valves with one or two solenoids. Common connection to ports 1 (pressure), 3 and 5 (exhaust). Ports 2 and 4 of the individual valves are also located in the manifold plate and equipped with 4 mm push-in fittings.

Valves are screwed from the top onto the modular manifold plate. Electric part is added afterwards. The electric part has a defined number of positions and can be chosen with cable connection either on the left or on the right side. The following illustration shows a TR 10 510 344.

The TL 10 has the connector on the opposite side.

Blanking plates are also available type BPM 5 304, displayed on page 2.6.2.4.

The valve terminal will be equipped and tested by the manufacturer. Please advise configuration.

End-plates do not offer a valve-position.

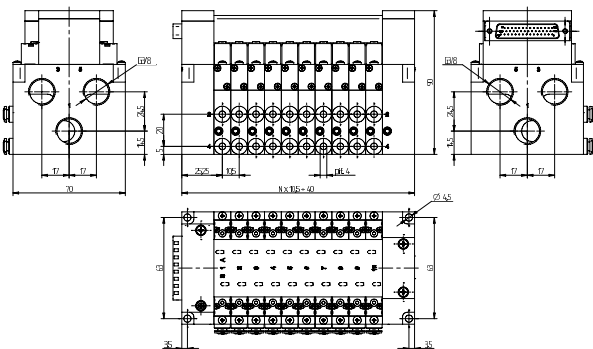

T_10 5__ 344

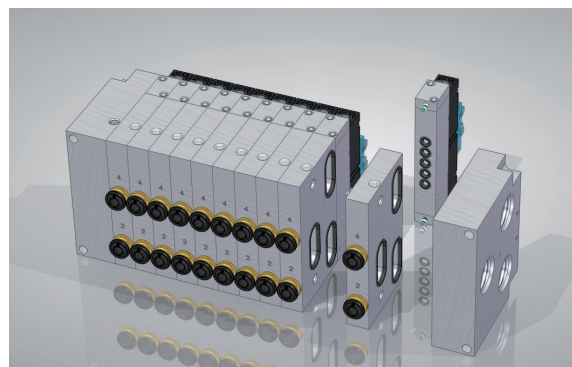

Element with ports 2+4 on the bottom:
RM 5 344 K1

Type	Connector	Ports	Comment
TR 10 5__ 344	On the right side	front side	Please amend the type nr. by the required positions
TL 10 5__ 344	On the left side	front side	Please amend the type nr. by the required positions
TR 10 5__ 344 K1	On the right side	bottom	Please amend the type nr. by the required positions
TL 10 5__ 344 K1	On the left side	bottom	Please amend the type nr. by the required positions

ST 54 20 L3000/ST 54 40 L3000



Straight electrical connector for 10 mm valve terminals.
Cable can be offset by 2 x 90°.
Standard cable length 3000 mm, others on request.

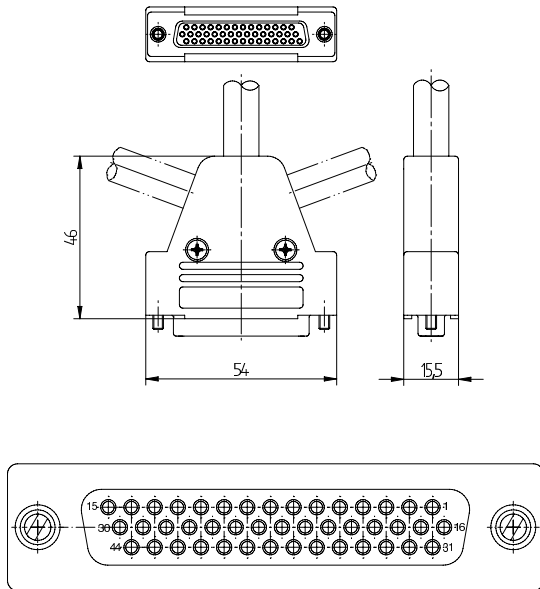

PIN-numbering

Valve	Solenoid	Colour	PIN
1	A	brown	23
	B	yellow	37
2	A	green	38
	B	red	22
3	A	blue	9
	B	pink	7
4	A	grey	24
	B	violet	36
5	A	black	39
	B	brown-green	21
6	A	white-green	10
	B	red-blue	6
7	A	grey-pink	25
	B	yellow-brown	35
8	A	white-yellow	40
	B	pink-brown	20
9	A	white-pink	11
	B	grey-brown	5
10	A	white-grey	26
	B	white-red	34
11	A	white-blue	41
	B	grey-green	19
12	A	brown-black	12
	B	white-black	4
13	A	brown-red	27
	B	pink-green	33
14	A	yellow-grey	42
	B	green-red	18
15	A	yellow-blue	13
	B	green-blue	3
16	A	yellow-pink	28
	B	grey-blue	32
17	A	yellow-black	29
	B	green-black	17
18	A	yellow-red	43
	B	grey-red	2
19	A	pink-blue	14
	B	grey-black	31
20	A	pink-red	44
	B	blue-black	16
common +/- up to 10 valves		white	8
2. common +/- for 10 to 20 valves		brown-blue	8
Without function		pink-black	
		red-black	

Solenoid A and B are marked on the terminal.
For TR10 solenoids A are on valve-side 12,
the B solenoids are on valve-side 14.
For TL10 solenoids A are on valve-side 14,
the B solenoids are on valve-side 12.

Type	Comment
ST 54 20 L3000	Connector for up to 10 valves
ST 54 40 L3000	Connector for up to 20 valves



HAFNER

aim fluid control sinds 1995. Als onafhankelijke specialist in het meten en regelen van diverse soorten vloeistof- en gasstromen (Flow & Fluid Technology) richt aim zich op de professionele markt. De markt met de behoefte aan standaardproducten tot aan engineeringprojecten die verregaande technische kennis vereisen op het gebied van afsluiters, magneetventielen, pneumatiek ventielen, actuators, appendages, vacuümpompen, compressoren, fittingen en toebehoren.

Vanuit het hoofdkantoor en magazijn te Son & Breugel, nabij Science Park Ekkersrijt, ontzorgt aim zijn klanten van A tot Z en biedt technische en logistieke maatwerkoplossingen door gedegen kennis, een gedreven en persoonlijke service én een klantspecifiek voorraadbeheer.

Ontzorgend, **Betrokken** & **Verantwoordelijk**

aim fluid control b.v.
Ekkersrijt 7310-7312
5692 HH Son en Breugel / Nederland
T. +31(0) 499 49 10 90
E. info@aimfluid.nl
F. +31(0) 499 49 63 70
I. www.aimfluid.nl

Hafner-Pneumatik Krämer KG
Stammheimer Straße 10
D-70806 Kornwestheim
T. +49 - 71 54 - 17 85 890
F. +49 - 71 54 - 17 85 89 28
E. info@hafner-pneumatik.de
I. www.hafner-pneumatik.de

